

Installation Instructions

TAMPER-RESISTANT OUTLET 15A-125V

READ THESE INSTRUCTIONS
BEFORE INSTALLING

DI-000-E5325-02B-W

Cat. No. E5325

★ SAFER, FASTER, and EASIER

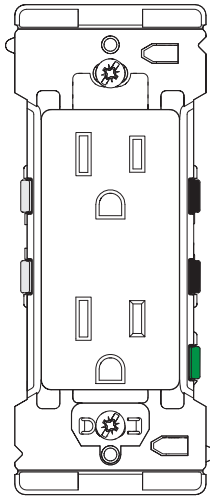

Leviton's Lever Edge Tamper-Resistant Outlet makes it safer, faster, and easier to install a new outlet.

Colored levers easily identify where to connect each wire.

There are no exposed wires or metal parts after installation.

Built-in strip gauge.

An extra large plastic strap facilitates installation in large wall openings.

Designed for midway wallplates for extra coverage, or you can easily convert it to use with standard wallplates by removing the break-off tabs.

Built-in alignment feature to align other Lever Edge products in a multi-gang installation. (See page 13.)

1

★ Features

Terminates wire with a snap

The colored levers snap shut to terminate the wires.

Alignment Tab and Notch

Aligns devices for multi-gang installations.

Strap

Levers

Split Circuit Cover

Covers the split circuit tab from live wire access. Break off for split circuits.

Levers

Break-off Fins

Break off to install a standard size wallplate.

Strip Gauge

2

★ Lever Wiring Feature

The color-coded levers easily identify where to connect the wallbox wires to the outlet.

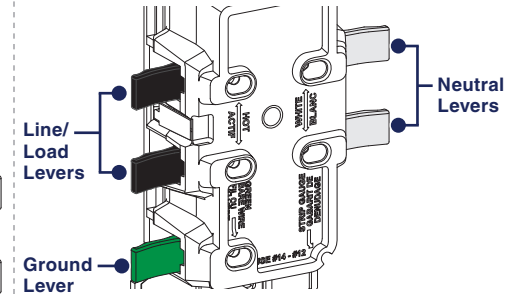

NOTE: Wire colors in your wallbox may be different from the lever colors. See "Preparing Wires," on page 5 to make sure you insert the wires properly.

3

If you need help...

ONLINE
www.leviton.com/support

CHAT
www.leviton.com/contact

CALL
1-800-824-3005 (USA)
1-800-405-5320 (Canada)

Leviton Manufacturing Co., Inc.
201 North Service Road, Melville, NY 11747

© 2025 Leviton Manufacturing Co., Inc. All rights reserved.

Specifications subject to change at any time without notice.

🔧 Recommended Tools

Slotted/Phillips Screwdriver

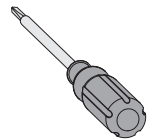

Wire Stripper



Needle Nose Pliers

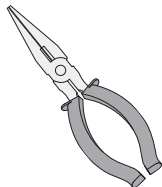

Voltage Tester

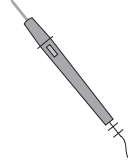

4

🔌 Preparing Wires

WARNING: TO AVOID FIRE, SHOCK, OR DEATH, TURN OFF POWER at circuit breaker or fuse and test that power is OFF before wiring!

1. Make sure that the ends of the wires from the wallbox are straight (**cut if necessary**).

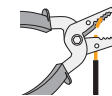

NOTES:

- Use with #12 AWG or #14 AWG solid or stranded copper wire only.
 - **DO NOT** use copper clad wires with this device.
2. Strip each wire in the wallbox, as shown below.

Use Built-in Strip Gauge on the Outlet

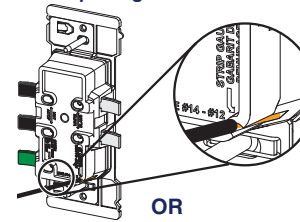

OR
Use Strip Gauge as shown below (measure bare wire here)



5

🔌 Wiring Your Device

1. Remove the existing outlet.
2. Verify that you have a Line (Black) wire, Neutral (White) wire, and a Ground (Bare Copper or Green) wire.

NOTE: Work on only one connection at a time.

3. Fully open lever.

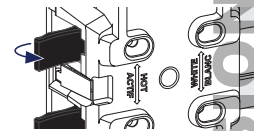

4. Insert the proper wire per lever color into the wire hole. Make sure the wire is fully inserted and no bare wire is exposed.

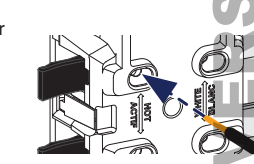

NOTE: If using stranded wire twist wire before insertion.

5. Fully close lever.

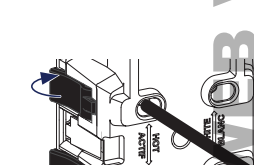

6. To complete wiring, proceed to page 7 or 8.

6

Common Feed Wiring

1. Connect the wires as shown.

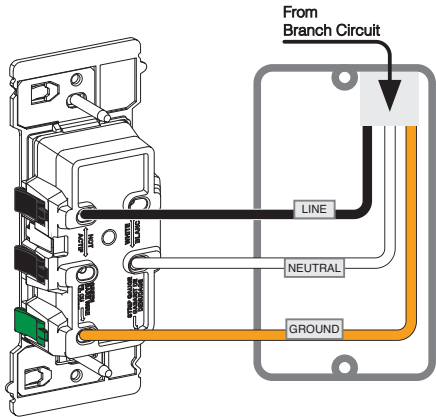

If your back box looks different, consult an electrician

7

Split Circuit Wiring

1. Open split circuit cover.

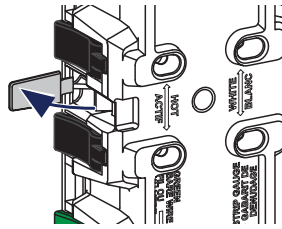

2. Break off split circuit tab and then close cover.

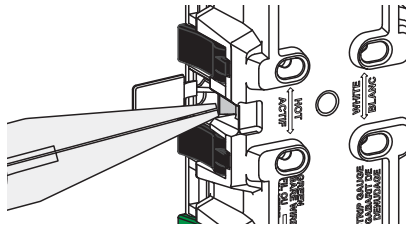

8

Split Circuit Wiring (continued)

3. Connect the wires as shown.

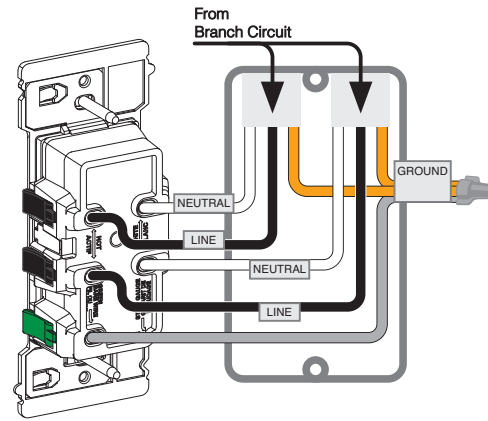

If your back box looks different, consult an electrician

9

Test

1. Position all wires so that there is room in the wallbox for the device.
2. Partially screw the mounting screws into the wallbox's mounting holes.

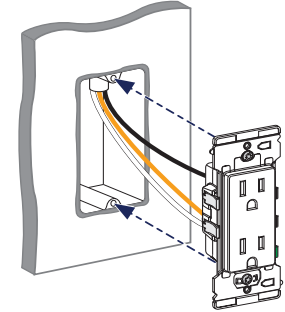

3. Restore power at the circuit breaker or fuse.
4. Test outlet.

WARNING: Turn the power OFF at the breaker or fuse before you complete the installation.

5. To complete the installation, proceed to the next page.

If you are unsure about the installation process, contact Leviton Technical Support, or contact an electrician.

10

Wallplate Installation Preparation

The outlet strap is designed for midway wallplates. If you want to use a standard size wallplate, carefully remove both break-off fins, as shown below.

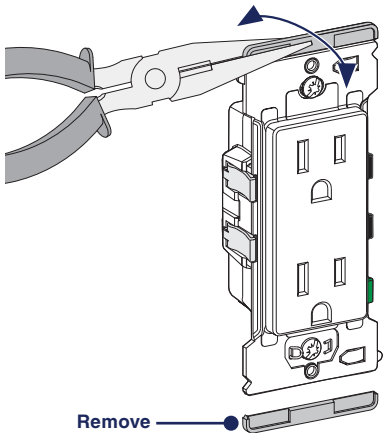

11

Single-Gang Box Installation

WARNING: Turn the power OFF at the circuit breaker before you tighten the screws.

1. Tighten the mounting screws into wallbox.

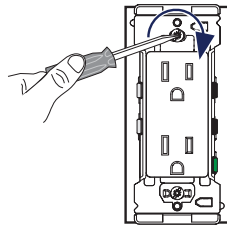

2. Install wallplate, and restore power.

12

Multi-Gang Box Installation

WARNING: Turn the power OFF at the circuit breaker before you tighten the screws.

1. To install the outlet next to other Lever Edge devices, use the alignment feature to easily place each device next to each other in the multi-gang box.

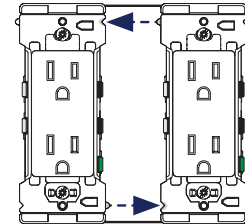

2. Tighten the mounting screws into wallbox.

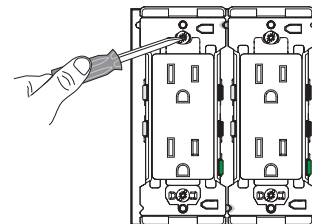

3. Install wallplate, and restore power.

13

Safety First

WARNINGS:

- TO AVOID FIRE SHOCK OR DEATH: TURN OFF POWER at circuit breaker or fuse when servicing, installing or removing device.
- This product is to be installed and/or used in accordance with electrical codes and regulations.
- If you are unsure about any part of these instructions, consult an electrician.

CAUTIONS:

- Use this device with **solid or stranded copper wire only**.
- **DO NOT** use this device with copper clad wire.
- To avoid damage to the product, **DO NOT** use disinfecting products, including foggers, sprays or other types of atomized cleaning agents.
- **DO NOT** spray liquid onto the product.
- To clean, use a damp cloth with mild soap.

PATENT STATEMENT
Patents covering this product, if any, can be found on Leviton.com/patents.

Limited 2 Year Warranty & Exclusions

For Leviton's limited product warranty, go to www.leviton.com. For a printed copy of the warranty, call 1-800-824-3005.

FOR CANADA ONLY

For warranty information and/or product returns, residents of Canada should contact Leviton in writing at **Leviton Manufacturing of Canada ULC** to the attention of the **Quality Assurance Department**, 165 Hymus Blvd, Pointe-Claire (Quebec), Canada H9R 1E9 or by telephone at 1 800 405-5320.

Scan this QR code for additional Lever Edge product information and to view the install video.



Visit leviton.com/support or contact Technical Services at 1-800-824-3005 for additional help.

WEB VERSION